

PROJECT	
TYPE	
SPECIFIER	
QUANTITY	
DATE	

CRYSTAL GALAXY SUSPENSION

D101389-

base number	LED Dimming	Color Temperature	Finish Options
-------------	-------------	-------------------	----------------

- To build a product code in our configurator select the specify button on the base model # product page
- To build a manual product code on this datasheet choose from the options listed below in blue font and add the suffix to the base model #

GENERAL

Series: Crystal Galaxy
Brand: Quasar
Division: Design
Mounting Type: Suspension
Mounting Location: Ceiling
Subcategory: Ambient

PHYSICAL

Shape: Abstract
Diameter (mm): 800
Diameter (in): 31 1/2
Height (mm): 800
Height (in): 31 1/2
Max. Overall Height (mm): 2000
Max. Overall Height (in): 78 3/4
Light Distribution: Omnidirectional
Weight (kg): 3
Weight (lbs): 6.61
Diffuser: Asfour Crystals
Fixture Finish: NIC / BRA / BBR
Fixture Material: Metal
Upon Request: Custom Sizes

ELECTRICAL

Number of Lamps: 60
Lamp Type: LED Retrofit
Input Wattage (W): 19.8
Bulb Included: Bulb Included
Max. Wattage Per Lamp (W): 0.33
Lamp Base: E10
Dimming: 0-10V Dimming / Phase Dimming (120Vac Only)
Driver Included: Yes
Driver Location: Integrated
Driver Type: Constant Voltage - Universal
Driver Class: Class 2
Input Voltage (V): 120 - 277
Output Voltage (V): 12
Lamp Voltage (V): 12

LED

Color Temperature (°K): 2600 / 3000 / 3500
Max. Delivered Lumen (lm): 1380 (2600K)
CRI: >90 CRI
Lamp Life (hrs): 50000

OPTICAL

RATINGS AND CERTIFICATIONS

Certified By: Certified for North American Standards
IP rating: IP20

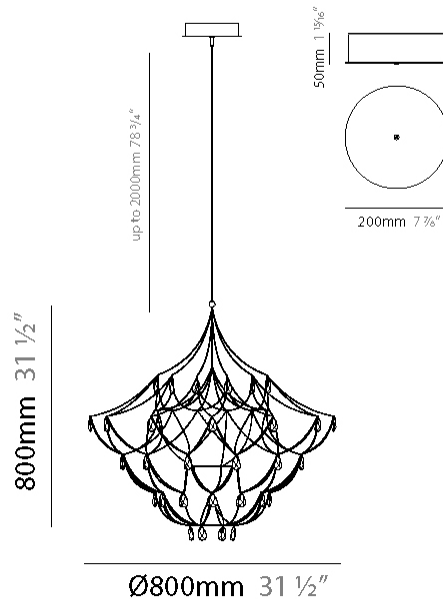

CRYSTAL GALAXY SUSPENSION

D101389-

PROJECT

TYPE

SPECIFIER

QUANTITY

DATE



PROJECT	
TYPE	
SPECIFIER	
QUANTITY	
DATE	

CRYSTAL GALAXY SUSPENSION

D101390-

base number	LED Dimming	Color Temperature	Finish Options
-------------	-------------	-------------------	----------------

- To build a product code in our configurator select the specify button on the base model # product page
- To build a manual product code on this datasheet choose from the options listed below in blue font and add the suffix to the base model #

GENERAL

Series: Crystal Galaxy
Brand: Quasar
Division: Design
Mounting Type: Suspension
Mounting Location: Ceiling
Subcategory: Ambient

PHYSICAL

Shape: Abstract
Diameter (mm): 800
Diameter (in): 31 1/2
Height (mm): 800
Height (in): 31 1/2
Max. Overall Height (mm): 2000
Max. Overall Height (in): 78 3/4
Light Distribution: Omnidirectional
Diffuser: Asfour Crystals
Fixture Finish: NIC / BRA / BBR
Fixture Material: Metal
Upon Request: Custom Sizes

ELECTRICAL

Number of Lamps: 60 + 1
Lamp Type: LED Retrofit
Input Wattage (W): 26.8
Bulb Included: Bulb Included
Max. Wattage Per Lamp (W): 0.33 + 7
Lamp Base: E10 + GU10
Dimming: 0-10V Dimming / Phase Dimming (120Vac Only)
Driver Included: Yes
Driver Location: Integrated
Driver Type: Constant Voltage - Universal
Driver Class: Class 2
Input Voltage (V): 120 - 277
Output Voltage (V): 12
Lamp Voltage (V): 12

LED

Color Temperature (°K): 2600 / 3000 / 3500
CRI: >90 CRI
Lamp Life (hrs): 50000

OPTICAL

RATINGS AND CERTIFICATIONS

Certified By: Certified for North American Standards
IP rating: IP20

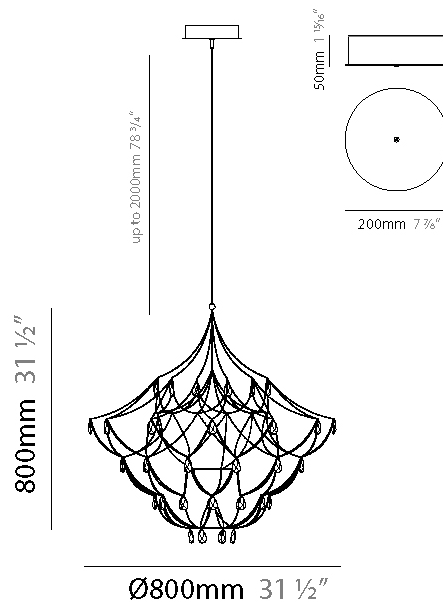

CRYSTAL GALAXY SUSPENSION

D101390-

PROJECT _____

TYPE _____

SPECIFIER _____

QUANTITY _____

DATE _____



D

CRYSTAL GALAXY SUSPENSION

D101393-

base number LED Color Finish
 Dimming Temperature Options

- To build a product code in our configurator select the specify button on the base model # product page
- To build a manual product code on this datasheet choose from the options listed below in blue font and add the suffix to the base model #

GENERAL

Series: Crystal Galaxy
 Brand: Quasar
 Division: Design
 Mounting Type: Suspension
 Mounting Location: Ceiling
 Subcategory: Ambient

PHYSICAL

Shape: Abstract
 Diameter (mm): 600
 Diameter (in): 23 5/8
 Height (mm): 600
 Height (in): 23 5/8
 Max. Overall Height (mm): 2000
 Max. Overall Height (in): 78 3/4
 Light Distribution: Omnidirectional
 Weight (kg): 3
 Weight (lbs): 6.61
 Fixture Finish: [NIC / BRA / BBR](#)
 Fixture Material: Metal
 Upon Request: Custom Sizes

ELECTRICAL

Number of Lamps: 48
 Lamp Type: LED Retrofit
 Input Wattage (W): 15.84
 Bulb Included: Bulb Included
 Max. Wattage Per Lamp (W): 0.33
 Lamp Base: E10
 Dimming: [0-10V Dimming / Phase Dimming \(120Vac Only\)](#)
 Driver Included: Yes
 Driver Location: Integrated
 Driver Type: Constant Voltage - Universal
 Driver Class: Class 2
 Input Voltage (V): 120 - 277
 Output Voltage (V): 12
 Lamp Voltage (V): 12

LED

[Color Temperature \(°K\): 2600 / 3000 / 3500](#)
 Max. Delivered Lumen (lm): 1104 (2600K)
 CRI: >90 CRI
 Lamp Life (hrs): 50000

OPTICAL

RATINGS AND CERTIFICATIONS

Certified By: Certified for North American Standards
 IP rating: IP20

PROJECT
TYPE
SPECIFIER
QUANTITY
DATE

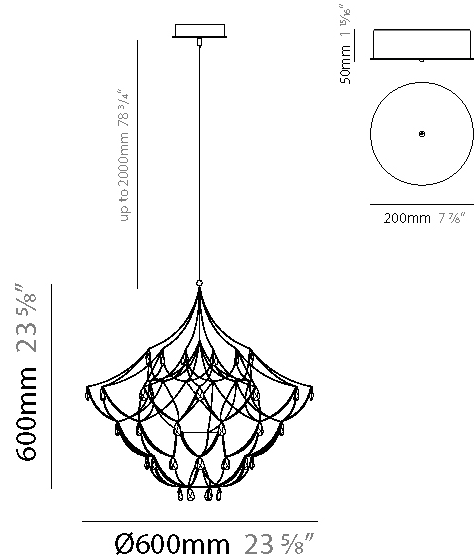

CRYSTAL GALAXY SUSPENSION

D101393-

PROJECT

TYPE

SPECIFIER

QUANTITY

DATE



D

PROJECT	
TYPE	
SPECIFIER	
QUANTITY	
DATE	

CRYSTAL GALAXY SUSPENSION

D101394-

base number	LED Dimming	Color Temperature	Finish Options
-------------	-------------	-------------------	----------------

- To build a product code in our configurator select the specify button on the base model # product page
- To build a manual product code on this datasheet choose from the options listed below in blue font and add the suffix to the base model #

GENERAL

Series: Crystal Galaxy
Brand: Quasar
Division: Design
Mounting Type: Suspension
Mounting Location: Ceiling
Subcategory: Ambient

PHYSICAL

Shape: Abstract
Diameter (mm): 600
Diameter (in): 23 5/8
Height (mm): 600
Height (in): 23 5/8
Max. Overall Height (mm): 2000
Max. Overall Height (in): 78 3/4
Light Distribution: Omnidirectional
Fixture Finish: NIC / BRA / BBR
Fixture Material: Metal
Upon Request: Custom Sizes

ELECTRICAL

Number of Lamps: 48 + 1
Lamp Type: LED Retrofit
Input Wattage (W): 22.84
Bulb Included: Bulb Included
Max. Wattage Per Lamp (W): 0.33 + 7
Lamp Base: E10 + GU10
Dimming: 0-10V Dimming / Phase Dimming (120Vac Only)
Driver Included: Yes
Driver Location: Integrated
Driver Type: Constant Voltage - Universal
Driver Class: Class 2
Input Voltage (V): 120 - 277
Output Voltage (V): 12
Lamp Voltage (V): 12

LED

Color Temperature (*K): 2600 / 3000 / 3500
CRI: >90 CRI
Lamp Life (hrs): 50000

OPTICAL

RATINGS AND CERTIFICATIONS

Certified By: Certified for North American Standards
IP rating: IP20

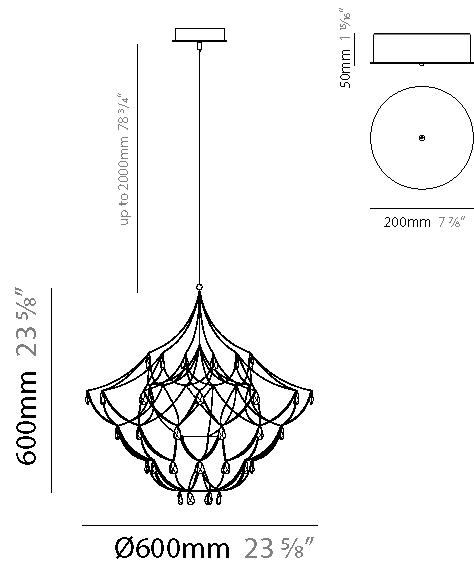

CRYSTAL GALAXY SUSPENSION

D101394-

PROJECT

TYPE

SPECIFIER

QUANTITY

DATE



D

CRYSTAL GALAXY SUSPENSION

D101397-

base number LED Dimming Color Temperature Finish Options

PROJECT
TYPE
SPECIFIER
QUANTITY
DATE

- To build a product code in our configurator select the specify button on the base model # product page
- To build a manual product code on this datasheet choose from the options listed below in blue font and add the suffix to the base model #

GENERAL

Series: Crystal Galaxy
 Brand: Quasar
 Division: Design
 Mounting Type: Suspension
 Mounting Location: Ceiling
 Subcategory: Ambient

PHYSICAL

Shape: Abstract
 Diameter (mm): 1000
 Diameter (in): 39 3/8
 Height (mm): 1000
 Height (in): 39 3/8
 Max. Overall Height (mm): 2000
 Max. Overall Height (in): 78 3/4
 Light Distribution: Omnidirectional
 Weight (kg): 3
 Weight (lbs): 6.61
 Fixture Finish: [NIC / BRA / BBR](#)
 Fixture Material: Metal
 Upon Request: Custom Sizes

ELECTRICAL

Number of Lamps: 75
 Lamp Type: LED Retrofit
 Input Wattage (W): 24.75
 Bulb Included: Bulb Included
 Max. Wattage Per Lamp (W): 0.33
 Lamp Base: E12
 Dimming: [0-10V Dimming / Phase Dimming \(120Vac Only\)](#)
 Driver Included: Yes
 Driver Location: Integrated
 Driver Type: Constant Voltage - Universal
 Driver Class: Class 2
 Input Voltage (V): 120 - 277
 Output Voltage (V): 12
 Lamp Voltage (V): 12

LED

[Color Temperature \(°K\): 2600 / 3000 / 3500](#)
 Max. Delivered Lumen (lm): 1725 (2600K)
 CRI: >80 CRI
 Lamp Life (hrs): 50000

OPTICAL

RATINGS AND CERTIFICATIONS

Certified By: Certified for North American Standards
 IP rating: IP20

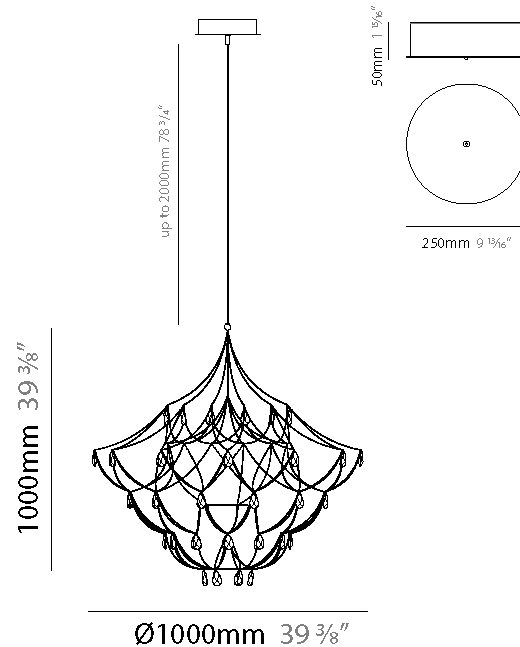

CRYSTAL GALAXY SUSPENSION

D101397-

PROJECT

TYPE

SPECIFIER

QUANTITY

DATE



D

PROJECT	
TYPE	
SPECIFIER	
QUANTITY	
DATE	

CRYSTAL GALAXY SUSPENSION

D101398-

base number	LED Dimming	Color Temperature	Finish Options
-------------	-------------	-------------------	----------------

- To build a product code in our configurator select the specify button on the base model # product page
- To build a manual product code on this datasheet choose from the options listed below in blue font and add the suffix to the base model #

GENERAL

Series: Crystal Galaxy
Brand: Quasar
Division: Design
Mounting Type: Suspension
Mounting Location: Ceiling
Subcategory: Ambient

PHYSICAL

Shape: Abstract
Diameter (mm): 1000
Diameter (in): 39 3/8"
Height (mm): 1000
Height (in): 39 3/8"
Max. Overall Height (mm): 2000
Max. Overall Height (in): 78 3/4"
Light Distribution: Omnidirectional
Fixture Finish: NIC / BRA / BBR
Fixture Material: Metal
Upon Request: Custom Sizes

ELECTRICAL

Number of Lamps: 75 + 1
Lamp Type: LED Retrofit
Input Wattage (W): 31.75
Bulb Included: Bulb Included
Max. Wattage Per Lamp (W): 0.33 + 7
Lamp Base: E10 + GU10
Dimming: 0-10V Dimming / Phase Dimming (120Vac Only)
Driver Included: Yes
Driver Location: Integrated
Driver Type: Constant Voltage - Universal
Driver Class: Class 2
Input Voltage (V): 120 - 277
Output Voltage (V): 12
Lamp Voltage (V): 12

LED

Color Temperature (*K): 2600 / 3000 / 3500
CRI: >90 CRI
Lamp Life (hrs): 50000

OPTICAL

RATINGS AND CERTIFICATIONS

Certified By: Certified for North American Standards
IP rating: IP20

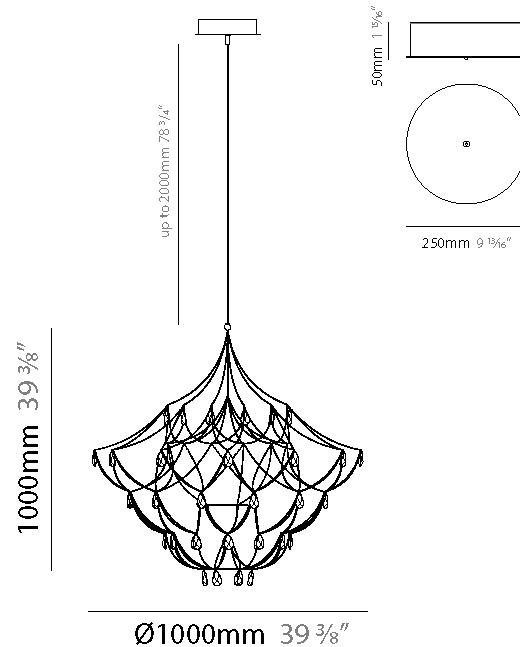

CRYSTAL GALAXY SUSPENSION

D101398-

PROJECT

TYPE

SPECIFIER

QUANTITY

DATE



PROJECT	_____
TYPE	_____
SPECIFIER	_____
QUANTITY	_____
DATE	_____

CRYSTAL GALAXY SUSPENSION

D101401-

base number	LED	Color	Finish
	Dimming	Temperature	Options

- To build a product code in our configurator select the specify button on the base model # product page
- To build a manual product code on this datasheet choose from the options listed below in blue font and add the suffix to the base model #

GENERAL

Series: Crystal Galaxy
Brand: Quasar
Division: Design
Mounting Type: Suspension
Mounting Location: Ceiling
Subcategory: Ambient

PHYSICAL

Shape: Abstract
Diameter (mm): 1200
Diameter (in): 47 1/4
Height (mm): 1200
Height (in): 47 1/4
Max. Overall Height (mm): 3200
Max. Overall Height (in): 126
Light Distribution: Omnidirectional
Weight (kg): 4
Weight (lbs): 8.82
Fixture Finish: NIC / BRA / BBR
Fixture Material: Metal
Cable Details: 2000mm Cable
Upon Request: Custom Sizes

ELECTRICAL

Number of Lamps: 108
Lamp Type: LED Retrofit
Input Wattage (W): 35.64
Bulb Included: Bulb Included
Max. Wattage Per Lamp (W): 0.33
Lamp Base: E10
Dimming: 0-10V Dimming / Phase Dimming (120Vac Only)
Driver Included: Yes
Driver Location: Integrated
Driver Type: Constant Voltage - Universal
Driver Class: Class 2
Input Voltage (V): 120 - 277
Output Voltage (V): 12
Lamp Voltage (V): 12

LED

Color Temperature (*K): 2600 / 3000 / 3500
Max. Delivered Lumen (lm): 2484 (2600K)
CRI: >90 CRI
Lamp Life (hrs): 50000

OPTICAL

RATINGS AND CERTIFICATIONS

Certified By: Certified for North American Standards
IP rating: IP20

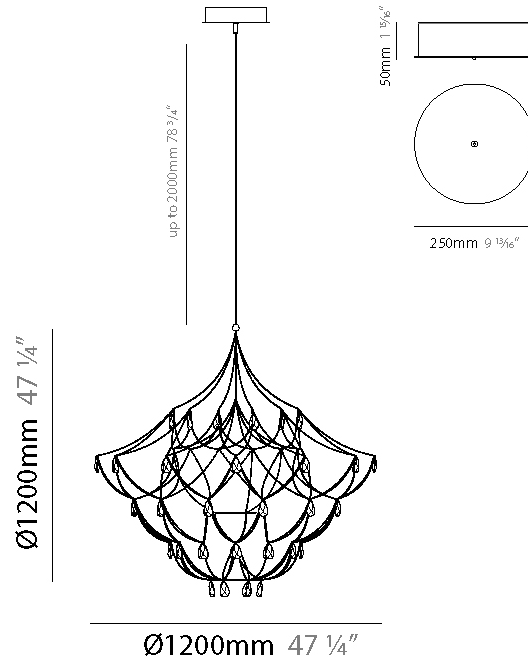

CRYSTAL GALAXY SUSPENSION

D101401-

PROJECT

TYPE

SPECIFIER

QUANTITY

DATE



D

PROJECT	_____
TYPE	_____
SPECIFIER	_____
QUANTITY	_____
DATE	_____

CRYSTAL GALAXY SUSPENSION

D101402-

base number	LED Dimming	Color Temperature	Finish Options
-------------	----------------	----------------------	-------------------

- To build a product code in our configurator select the specify button on the base model # product page
- To build a manual product code on this datasheet choose from the options listed below in blue font and add the suffix to the base model #

GENERAL

Series: Crystal Galaxy
Brand: Quasar
Division: Design
Mounting Type: Suspension
Mounting Location: Ceiling
Subcategory: Ambient

PHYSICAL

Shape: Abstract
Diameter (mm): 1200
Diameter (in): 47 1/4
Height (mm): 1200
Height (in): 47 1/4
Max. Overall Height (mm): 3200
Max. Overall Height (in): 126
Light Distribution: Omnidirectional
Fixture Finish: NIC / BRA / BBR
Fixture Material: Metal
Cable Details: 2000mm Cable
Upon Request: Custom Sizes

ELECTRICAL

Number of Lamps: 108 + 1
Lamp Type: LED Retrofit
Input Wattage (W): 42.64
Bulb Included: Bulb Included
Max. Wattage Per Lamp (W): 0.33 + 7
Lamp Base: E10 + GU10
Dimming: 0-10V Dimming / Phase Dimming (120Vac Only)
Driver Included: Yes
Driver Location: Integrated
Driver Type: Constant Voltage - Universal
Driver Class: Class 2
Input Voltage (V): 120 - 277
Output Voltage (V): 12
Lamp Voltage (V): 12

LED

Color Temperature (°K): 2600 / 3000 / 3500
CRI: >90 CRI
Lamp Life (hrs): 50000

OPTICAL

RATINGS AND CERTIFICATIONS

Certified By: Certified for North American Standards
IP rating: IP20

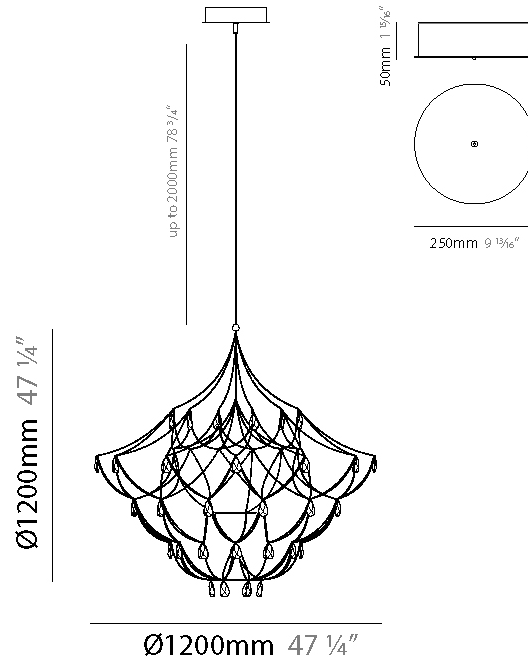

CRYSTAL GALAXY SUSPENSION

D101402-

PROJECT

TYPE

SPECIFIER

QUANTITY

DATE



D

PROJECT	_____
TYPE	_____
SPECIFIER	_____
QUANTITY	_____
DATE	_____

CRYSTAL GALAXY SUSPENSION

D101405-

base number	LED	Color	Finish
	Dimming	Temperature	Options

- To build a product code in our configurator select the specify button on the base model # product page
- To build a manual product code on this datasheet choose from the options listed below in blue font and add the suffix to the base model #

GENERAL

Series: Crystal Galaxy
Brand: Quasar
Division: Design
Mounting Type: Suspension
Mounting Location: Ceiling
Subcategory: Ambient

PHYSICAL

Shape: Abstract
Diameter (mm): 1400
Diameter (in): 55 1/8"
Height (mm): 1400
Height (in): 55 1/8"
Max. Overall Height (mm): 3400
Max. Overall Height (in): 133 7/8"
Light Distribution: Omnidirectional
Weight (kg): 5
Weight (lbs): 11.02
Fixture Finish: NIC / BRA / BBR
Fixture Material: Metal
Cable Details: 2000mm Cable

ELECTRICAL

Number of Lamps: 126
Lamp Type: LED Retrofit
Input Wattage (W): 41.58
Bulb Included: Bulb Included
Max. Wattage Per Lamp (W): 0.33
Lamp Base: E10
Dimming: 0-10V Dimming / Phase Dimming (120Vac Only)
Driver Included: Yes
Driver Location: Integrated
Driver Type: Constant Voltage - Universal
Driver Class: Class 2
Input Voltage (V): 120 - 277
Output Voltage (V): 12
Lamp Voltage (V): 12

LED

Color Temperature (°K): 2600 / 3000 / 3500
Max. Delivered Lumen (lm): 2898 (2600K)
CRI: >80 CRI
Lamp Life (hrs): 50000

OPTICAL

RATINGS AND CERTIFICATIONS

Certified By: Certified for North American Standards
IP rating: IP20

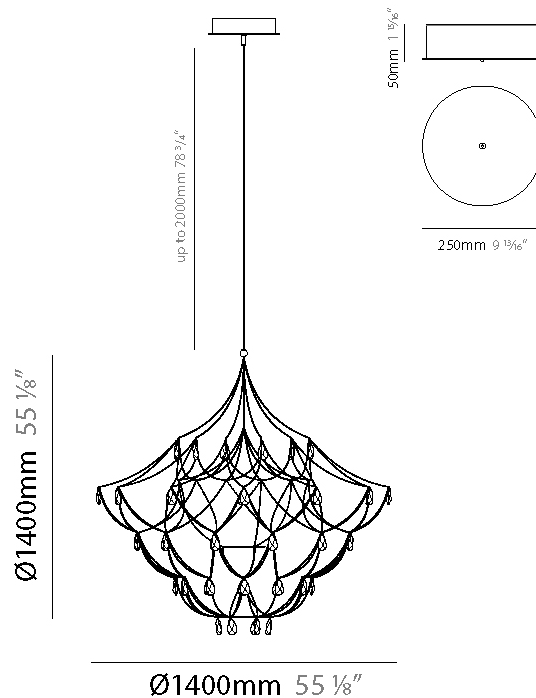

CRYSTAL GALAXY SUSPENSION

D101405-

PROJECT

TYPE

SPECIFIER

QUANTITY

DATE



D

PROJECT	_____
TYPE	_____
SPECIFIER	_____
QUANTITY	_____
DATE	_____

CRYSTAL GALAXY SUSPENSION

D101406-

base number	LED	Color	Finish
	Dimming	Temperature	Options

- To build a product code in our configurator select the specify button on the base model # product page
- To build a manual product code on this datasheet choose from the options listed below in blue font and add the suffix to the base model #

GENERAL

Series: Crystal Galaxy
Brand: Quasar
Division: Design
Mounting Type: Suspension
Mounting Location: Ceiling
Subcategory: Ambient

PHYSICAL

Shape: Abstract
Diameter (mm): 1400
Diameter (in): 55 1/8"
Height (mm): 1400
Height (in): 55 1/8"
Max. Overall Height (mm): 3400
Max. Overall Height (in): 133 7/8"
Light Distribution: Omnidirectional
Fixture Finish: NIC / BRA / BBR
Fixture Material: Metal
Cable Details: 2000mm Cable
Upon Request: Custom Sizes

ELECTRICAL

Number of Lamps: 126 + 1
Lamp Type: LED Retrofit
Input Wattage (W): 48.58
Bulb Included: Bulb Included
Max. Wattage Per Lamp (W): 0.33 + 7
Lamp Base: E10 + GU10
Dimming: Phase Dimming (120Vac Only)
Driver Included: Yes
Driver Location: Integrated
Driver Type: Constant Voltage - Universal
Driver Class: Class 2
Input Voltage (V): 120 - 277
Output Voltage (V): 12
Lamp Voltage (V): 12

LED

Color Temperature (°K): 2600 / 3000 / 3500
CRI: >90 CRI
Lamp Life (hrs): 50000

OPTICAL

RATINGS AND CERTIFICATIONS

Certified By: Certified for North American Standards
IP rating: IP20

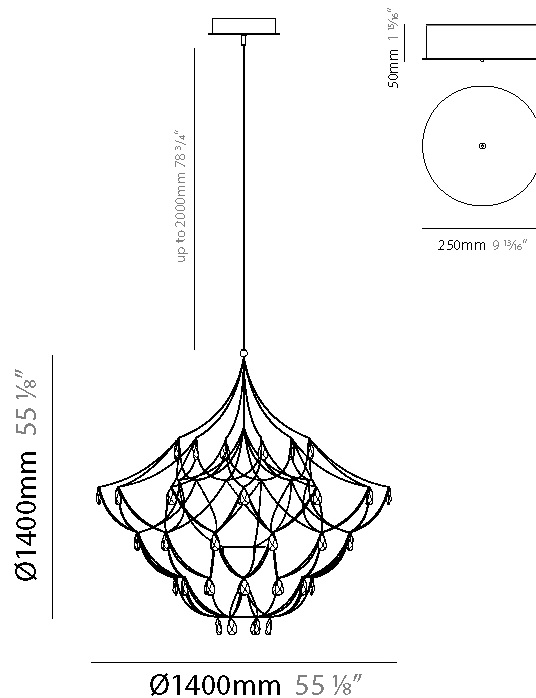

CRYSTAL GALAXY SUSPENSION

D101406-

PROJECT

TYPE

SPECIFIER

QUANTITY

DATE



D

PROJECT	
TYPE	
SPECIFIER	
QUANTITY	
DATE	

CRYSTAL GALAXY SUSPENSION

D101409-

base number	LED	Color	Finish
	Dimming	Temperature	Options

- To build a product code in our configurator select the specify button on the base model # product page
- To build a manual product code on this datasheet choose from the options listed below in blue font and add the suffix to the base model #

GENERAL

Series: Crystal Galaxy
Brand: Quasar
Division: Design
Mounting Type: Suspension
Mounting Location: Ceiling
Subcategory: Ambient

PHYSICAL

Shape: Abstract
Diameter (mm): 1600
Diameter (in): 63
Height (mm): 1600
Height (in): 63
Max. Overall Height (mm): 3600
Max. Overall Height (in): 141 3/4
Light Distribution: Omnidirectional
Weight (kg): 6
Weight (lbs): 13.23
Fixture Finish: NIC / BRA / BBR
Fixture Material: Metal
Cable Details: 2000mm Cable
Upon Request: Custom Sizes

ELECTRICAL

Number of Lamps: 144
Lamp Type: LED Retrofit
Input Wattage (W): 47.52
Bulb Included: Bulb Included
Max. Wattage Per Lamp (W): 0.33
Lamp Base: E10
Dimming: 0-10V Dimming / Phase Dimming (120Vac Only)
Driver Included: Yes
Driver Location: Integrated
Driver Type: Constant Voltage - Universal
Driver Class: Class 2
Input Voltage (V): 120 - 277
Output Voltage (V): 12
Lamp Voltage (V): 12

LED

Color Temperature (°K): 2600 / 3000 / 3500
Max. Delivered Lumen (lm): 3312 (2600K)
CRI: >90 CRI
Lamp Life (hrs): 50000

OPTICAL

RATINGS AND CERTIFICATIONS

Certified By: Certified for North American Standards
IP rating: IP20

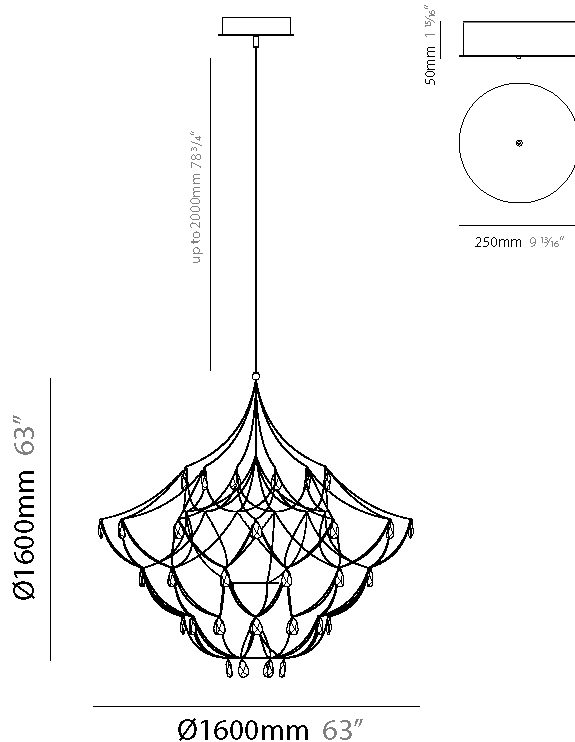

CRYSTAL GALAXY SUSPENSION

D101409-

PROJECT

TYPE

SPECIFIER

QUANTITY

DATE



D

PROJECT	
TYPE	
SPECIFIER	
QUANTITY	
DATE	

CRYSTAL GALAXY SUSPENSION

D101410-

base number	LED Dimming	Color Temperature	Finish Options
-------------	-------------	-------------------	----------------

- To build a product code in our configurator select the specify button on the base model # product page
- To build a manual product code on this datasheet choose from the options listed below in blue font and add the suffix to the base model #

GENERAL

Series: Crystal Galaxy
Brand: Quasar
Division: Design
Mounting Type: Suspension
Mounting Location: Ceiling
Subcategory: Ambient

PHYSICAL

Shape: Abstract
Diameter (mm): 1600
Diameter (in): 63
Height (mm): 1600
Height (in): 63
Max. Overall Height (mm): 3600
Max. Overall Height (in): 141 3/4
Light Distribution: Omnidirectional
Fixture Finish: NIC / BRA / BBR
Fixture Material: Metal
Cable Details: 2000mm Cable
Upon Request: Custom Sizes

ELECTRICAL

Number of Lamps: 144 + 1
Lamp Type: LED Retrofit
Input Wattage (W): 54.52
Bulb Included: Bulb Included
Max. Wattage Per Lamp (W): 0.33 + 7
Lamp Base: E10 + GU10
Dimming: 0-10V Dimming / Phase Dimming (120Vac Only)
Driver Included: Yes
Driver Location: Integrated
Driver Type: Constant Voltage - Universal
Driver Class: Class 2
Input Voltage (V): 120 - 277
Output Voltage (V): 12
Lamp Voltage (V): 12

LED

Color Temperature (°K): 2600 / 3000 / 3500
CRI: >90 CRI
Lamp Life (hrs): 50000

OPTICAL

RATINGS AND CERTIFICATIONS

Certified By: Certified for North American Standards
IP rating: IP20

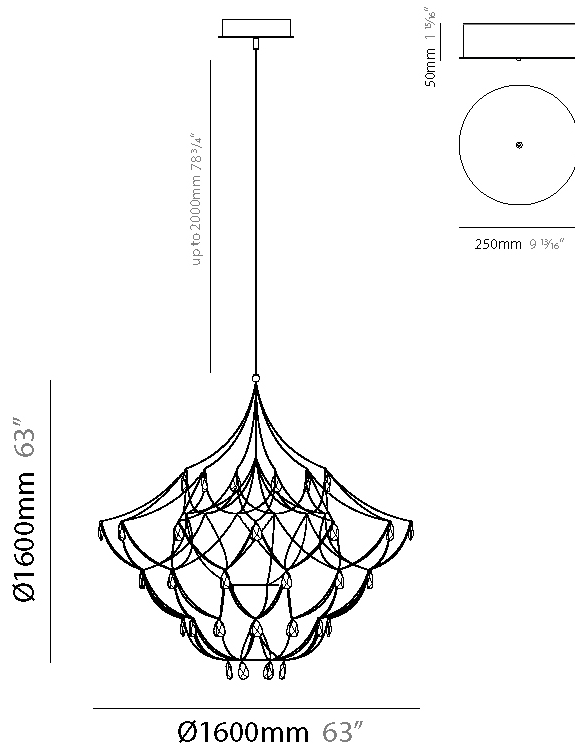

CRYSTAL GALAXY SUSPENSION

D101410-

PROJECT

TYPE

SPECIFIER

QUANTITY

DATE



PROJECT	_____
TYPE	_____
SPECIFIER	_____
QUANTITY	_____
DATE	_____

CRYSTAL GALAXY SUSPENSION

D101413-

base number	LED	Color	Finish
	Dimming	Temperature	Options

- To build a product code in our configurator select the specify button on the base model # product page
- To build a manual product code on this datasheet choose from the options listed below in blue font and add the suffix to the base model #

GENERAL

Series: Crystal Galaxy
Brand: Quasar
Division: Design
Mounting Type: Suspension
Mounting Location: Ceiling
Subcategory: Ambient

PHYSICAL

Shape: Abstract
Diameter (mm): 1800
Diameter (in): 70 7/8
Height (mm): 1800
Height (in): 70 7/8
Max. Overall Height (mm): 3800
Max. Overall Height (in): 149 5/8
Light Distribution: Omnidirectional
Weight (kg): 7
Weight (lbs): 15.43
Fixture Finish: NIC / BRA / BBR
Fixture Material: Metal
Cable Details: 2000mm Cable
Upon Request: Custom Sizes

ELECTRICAL

Number of Lamps: 150
Lamp Type: LED Retrofit
Input Wattage (W): 49.5
Bulb Included: Bulb Included
Max. Wattage Per Lamp (W): 0.33
Lamp Base: E10
Dimming: 0-10V Dimming / Phase Dimming (120Vac Only)
Driver Included: Yes
Driver Location: Integrated
Driver Type: Constant Voltage - Universal
Driver Class: Class 2
Input Voltage (V): 120 - 277
Output Voltage (V): 12
Lamp Voltage (V): 12

LED

Color Temperature (°K): 2600 / 3000 / 3500
Max. Delivered Lumen (lm): 3450 (2600K)
CRI: >90 CRI
Lamp Life (hrs): 50000

OPTICAL

RATINGS AND CERTIFICATIONS

Certified By: Certified for North American Standards
IP rating: IP20

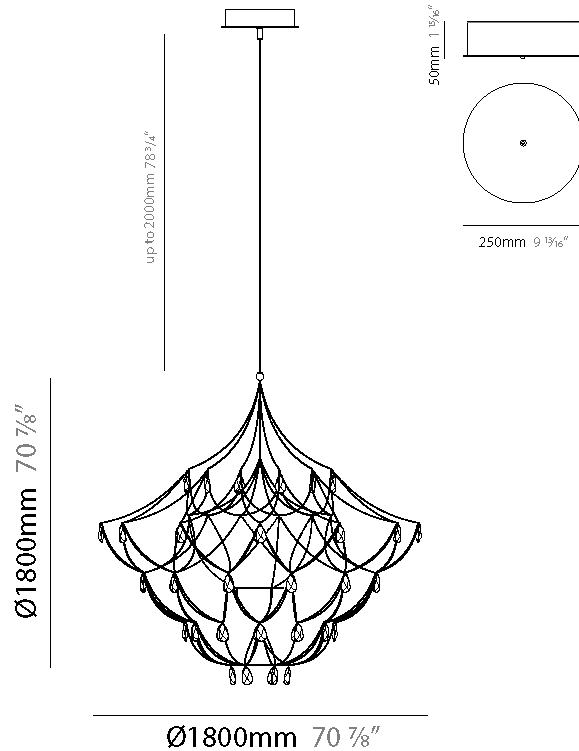

CRYSTAL GALAXY SUSPENSION

D101413-

PROJECT

TYPE

SPECIFIER

QUANTITY

DATE



PROJECT	
TYPE	
SPECIFIER	
QUANTITY	
DATE	

CRYSTAL GALAXY SUSPENSION

D101414-

base number	LED Dimming	Color Temperature	Finish Options
-------------	-------------	-------------------	----------------

- To build a product code in our configurator select the specify button on the base model # product page
- To build a manual product code on this datasheet choose from the options listed below in blue font and add the suffix to the base model #

GENERAL

Series: Crystal Galaxy
Brand: Quasar
Division: Design
Mounting Type: Suspension
Mounting Location: Ceiling
Subcategory: Ambient

PHYSICAL

Shape: Abstract
Diameter (mm): 1800
Diameter (in): 70 7/8
Height (mm): 1800
Height (in): 70 7/8
Max. Overall Height (mm): 3800
Max. Overall Height (in): 149 5/8
Light Distribution: Omnidirectional
Fixture Finish: NIC / BRA / BBR
Fixture Material: Metal
Cable Details: 2000mm Cable
Upon Request: Custom Sizes

ELECTRICAL

Number of Lamps: 150 + 1
Lamp Type: LED Retrofit
Input Wattage (W): 56.5
Bulb Included: Bulb Included
Max. Wattage Per Lamp (W): 0.33 + 7
Lamp Base: E10 + GU10
Dimming: 0-10V Dimming / Phase Dimming (120Vac Only)
Driver Included: Yes
Driver Location: Integrated
Driver Type: Constant Voltage - Universal
Driver Class: Class 2
Input Voltage (V): 120 - 277
Output Voltage (V): 12
Lamp Voltage (V): 12

LED

Color Temperature (°K): 2600
CRI: >90 CRI
Lamp Life (hrs): 50000

OPTICAL

RATINGS AND CERTIFICATIONS

Certified By: Certified for North American Standards
IP rating: IP20

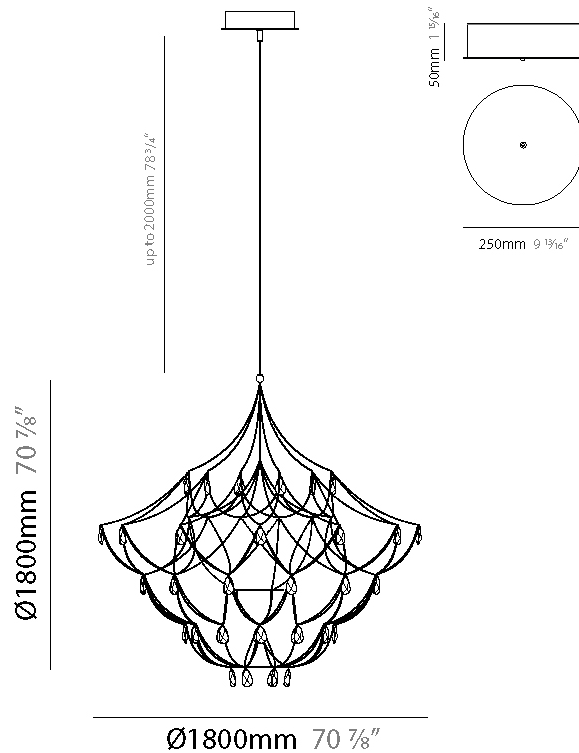

CRYSTAL GALAXY SUSPENSION

D101414-

PROJECT

TYPE

SPECIFIER

QUANTITY

DATE



PROJECT	
TYPE	
SPECIFIER	
QUANTITY	
DATE	

CRYSTAL GALAXY SUSPENSION

D101417-

base number	LED	Color	Finish
	Dimming	Temperature	Options

- To build a product code in our configurator select the specify button on the base model # product page
- To build a manual product code on this datasheet choose from the options listed below in blue font and add the suffix to the base model #

GENERAL

Series: Crystal Galaxy
Brand: Quasar
Division: Design
Mounting Type: Suspension
Mounting Location: Ceiling
Subcategory: Ambient

PHYSICAL

Shape: Abstract
Diameter (mm): 2000
Diameter (in): 78 3/4
Height (mm): 2000
Height (in): 78 3/4
Max. Overall Height (mm): 4000
Max. Overall Height (in): 157 1/2
Light Distribution: Omnidirectional
Weight (kg): 10
Weight (lbs): 22.05
Fixture Finish: NIC / BRA / BBR
Fixture Material: Metal
Cable Details: 2000mm Cable
Upon Request: Custom Sizes

ELECTRICAL

Number of Lamps: 156
Lamp Type: LED Retrofit
Input Wattage (W): 51.48
Bulb Included: Bulb Included
Max. Wattage Per Lamp (W): 0.33
Lamp Base: E10
Dimming: 0-10V Dimming / Phase Dimming (120Vac Only)
Driver Included: Yes
Driver Location: Integrated
Driver Type: Constant Voltage - Universal
Driver Class: Class 2
Input Voltage (V): 120 - 277
Output Voltage (V): 12
Lamp Voltage (V): 12

LED

Color Temperature (°K): 2600 / 3000 / 3500
Max. Delivered Lumen (lm): 3588 (2600K)
CRI: >90 CRI
Lamp Life (hrs): 50000

OPTICAL

RATINGS AND CERTIFICATIONS

Certified By: Certified for North American Standards
IP rating: IP20

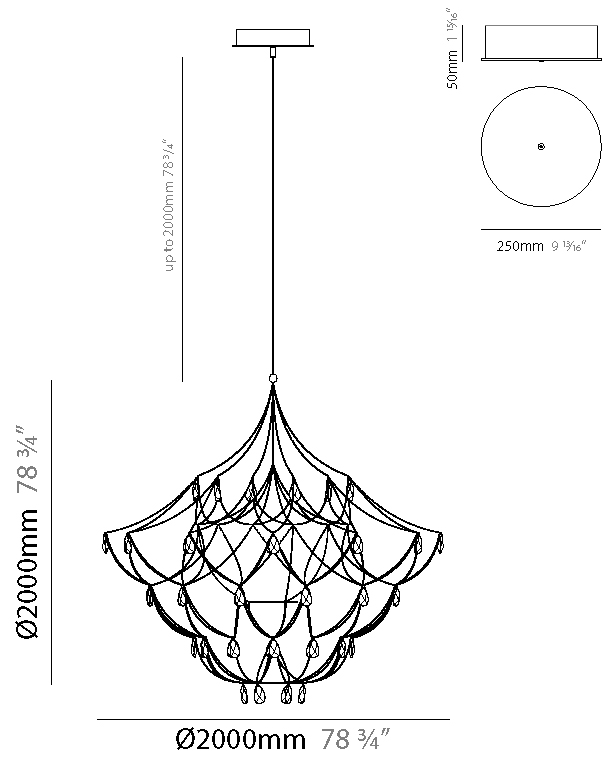

CRYSTAL GALAXY SUSPENSION

D101417-

PROJECT

TYPE

SPECIFIER

QUANTITY

DATE



D

PROJECT	_____
TYPE	_____
SPECIFIER	_____
QUANTITY	_____
DATE	_____

CRYSTAL GALAXY SUSPENSION

D101418-

base number	LED	Color	Finish
	Dimming	Temperature	Options

- To build a product code in our configurator select the specify button on the base model # product page
- To build a manual product code on this datasheet choose from the options listed below in blue font and add the suffix to the base model #

GENERAL

Series: Crystal Galaxy
Brand: Quasar
Division: Design
Mounting Type: Suspension
Mounting Location: Ceiling
Subcategory: Ambient

PHYSICAL

Shape: Abstract
Diameter (mm): 2000
Diameter (in): 78 3/4
Height (mm): 2000
Height (in): 78 3/4
Max. Overall Height (mm): 4000
Max. Overall Height (in): 157 1/2
Light Distribution: Omnidirectional
Fixture Finish: NIC / BRA / BBR
Fixture Material: Metal
Cable Details: 2000mm Cable
Upon Request: Custom Sizes

ELECTRICAL

Number of Lamps: 156 + 1
Lamp Type: LED Retrofit
Input Wattage (W): 58.48
Bulb Included: Bulb Included
Max. Wattage Per Lamp (W): 0.33 + 7
Lamp Base: E10 + GU10
Dimming: 0-10V Dimming / Phase Dimming (120Vac Only)
Driver Included: Yes
Driver Location: Integrated
Driver Type: Constant Voltage - Universal
Driver Class: Class 2
Input Voltage (V): 120 - 277
Output Voltage (V): 12
Lamp Voltage (V): 12

LED

Color Temperature (°K): 2600
CRI: >90 CRI
Lamp Life (hrs): 50000

OPTICAL

RATINGS AND CERTIFICATIONS

Certified By: Certified for North American Standards
IP rating: IP20

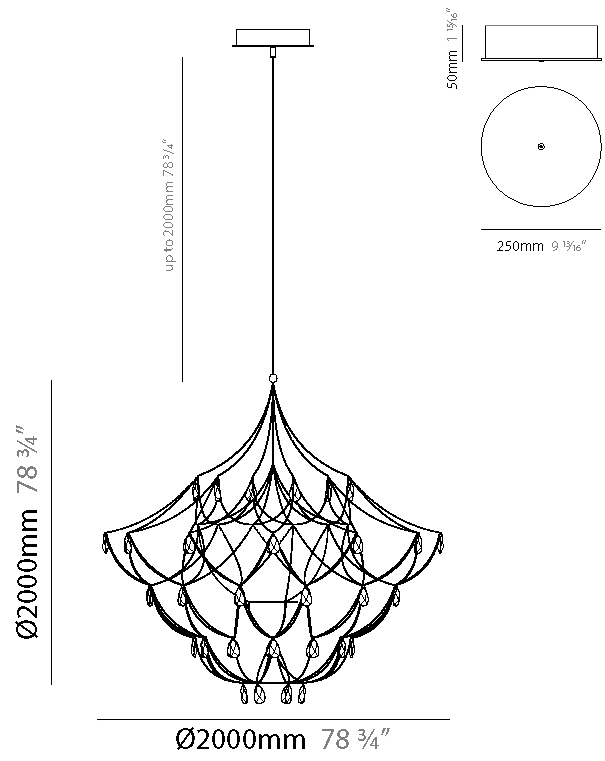

CRYSTAL GALAXY SUSPENSION

D101418-

PROJECT

TYPE

SPECIFIER

QUANTITY

DATE



D

CRYSTAL GALAXY SURFACE

D102028-

base number LED Color Finish
 Dimming Temperature Options

- To build a product code in our configurator select the specify button on the base model # product page
- To build a manual product code on this datasheet choose from the options listed below in blue font and add the suffix to the base model #

GENERAL

Series: Crystal Galaxy
 Brand: Quasar
 Division: Design
 Mounting Type: Surface
 Mounting Location: Ceiling
 Subcategory: Ambient

PHYSICAL

Shape: Abstract
 Diameter (mm): 800
 Diameter (in): 31 1/2
 Height (mm): 500
 Height (in): 19 11/16
 Light Distribution: Omnidirectional
 Weight (kg): 3
 Weight (lbs): 6.61
[Fixture Finish: NIC / BRA / BBR](#)
 Fixture Material: Metal
 Upon Request: Custom Sizes

ELECTRICAL

Number of Lamps: 54
 Lamp Type: LED Retrofit
 Input Wattage (W): 17.82
 Bulb Included: Bulb Included
 Max. Wattage Per Lamp (W): 0.33
 Lamp Base: E10
[Dimming: 0-10V Dimming / Phase Dimming \(120Vac Only\)](#)
 Driver Included: Yes
 Driver Location: Integrated
 Driver Type: Constant Voltage - Universal
 Driver Class: Class 2
 Input Voltage (V): 120 - 277
 Output Voltage (V): 12
 Lamp Voltage (V): 12

LED

[Color Temperature \(°K\): 2600 / 3000 / 3500](#)
 Max. Delivered Lumen (lm): 1242 (2600K)
 CRI: >80 CRI
 Lamp Life (hrs): 50000

OPTICAL

RATINGS AND CERTIFICATIONS

Certified By: Certified for North American Standards
 IP rating: IP20

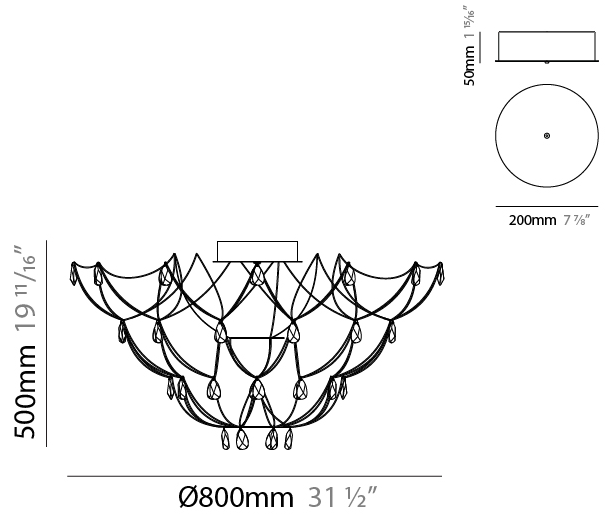

CRYSTAL GALAXY SURFACE

D102028-

PROJECT

TYPE

SPECIFIER

QUANTITY

DATE

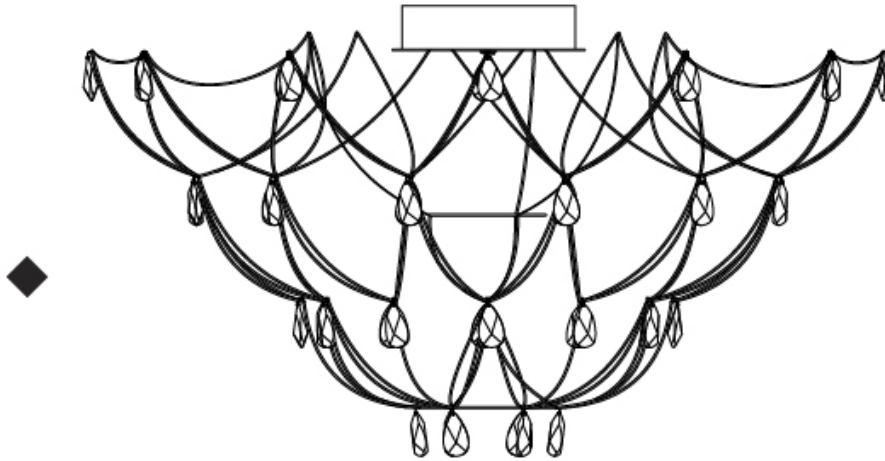

CRYSTAL GALAXY SURFACE

D102029-

base number LED Dimming Color Temperature Finish Options

- To build a product code in our configurator select the specify button on the base model # product page
- To build a manual product code on this datasheet choose from the options listed below in blue font and add the suffix to the base model #

GENERAL

Series: Crystal Galaxy
 Brand: Quasar
 Division: Design
 Mounting Type: Surface
 Mounting Location: Ceiling
 Subcategory: Ambient

PHYSICAL

Shape: Abstract
 Diameter (mm): 1000
 Diameter (in): 39 3/8
 Height (mm): 500
 Height (in): 19 11/16
 Light Distribution: Omnidirectional
 Weight (kg): 3
 Weight (lbs): 6.61
[Fixture Finish: NIC / BRA / BBR](#)
 Fixture Material: Metal
 Upon Request: Custom Sizes

ELECTRICAL

Number of Lamps: 66
 Lamp Type: LED Retrofit
 Input Wattage (W): 21.78
 Bulb Included: Bulb Included
 Max. Wattage Per Lamp (W): 0.33
 Lamp Base: E10
[Dimming: 0-10V Dimming / Phase Dimming \(120Vac Only\)](#)
 Driver Included: Yes
 Driver Location: Integrated
 Driver Type: Constant Voltage - Universal
 Driver Class: Class 2
 Input Voltage (V): 120 - 277
 Output Voltage (V): 12
 Lamp Voltage (V): 12

LED

[Color Temperature \(°K\): 2600 / 3000 / 3500](#)
 Max. Delivered Lumen (lm): 1518 (2600K)
 CRI: >80 CRI
 Lamp Life (hrs): 50000

OPTICAL

RATINGS AND CERTIFICATIONS

Certified By: Certified for North American Standards
 IP rating: IP20

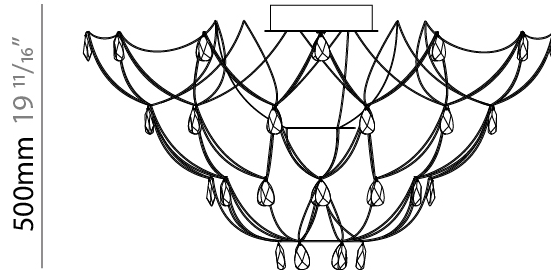
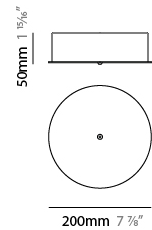

Ø1000mm 39 3/8"



CRYSTAL GALAXY SURFACE

D102029-

PROJECT

TYPE

SPECIFIER

QUANTITY

DATE

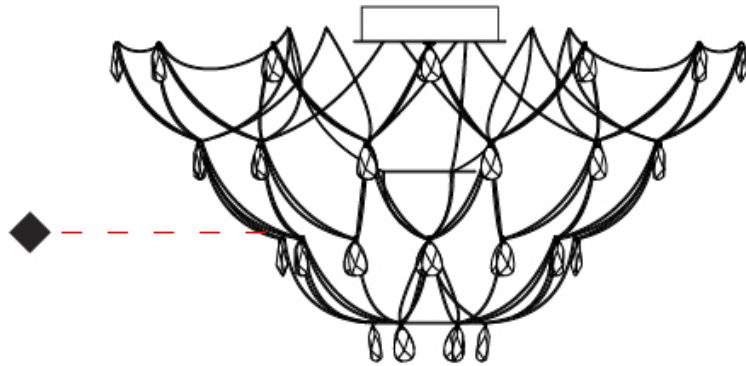

D

PROJECT _____

TYPE _____

SPECIFIER _____

QUANTITY _____

DATE _____

Fixture Finish

Nickel - NIC



Brass - BRA



Black Brass - BBR



Digital: Not all screens are calibrated the same, and therefore, colors will appear differently between screens.

Physical: When texture is involved, there will be variations in color, character and tone within a product series and between product families.

Brass, nickel and copper are natural minerals and can potentially change color and show marks over time. We cannot guarantee the color appearance as the material transforms.



PROJECT	
TYPE	
SPECIFIER	
QUANTITY	
DATE	

LEGEND

	floor-mounted		pivotal		special LED (upon request) RGB, RGBW, tunable, gold+, meat+, art+, fashion+
	wall and ceiling: recessed and surface mounted		rotating		warm dim / natural dimming LED
	ceiling-mounted and wall-mounted		illuminate tilted		rechargeable battery powered
	wall-mounted		color of suspension cable		fixture with natural vivid LED (upon request)
	omni-directional light distribution		length of suspension cable		color rendering index
	direct light distribution		reflector degree selection		color temperature
	direct/indirect light distribution		super spot		lumen (luminous flux)
	indirect light distribution		lens		efficacy (lumens per watt)
	asymmetric light distribution		lens pack		Unified Glare Rating (UGR) range from 5-40
	aura light distribution		shine ring		marine grade (AISI 316 stainless steel)
	round wall or ceiling cut-out		integrated shine ring with diffuser		walk on
	square wall or ceiling cut-out		free individual colors 01-29		drive on
	the supplied jig specifies the cutout dimensions		individual colors: 00 (free of charge), 01-25 (extra charge)		Dark Sky Compliance
	minimum distance (meters) lamp - object		luminaire part to be colored (F1)		Americans with Disabilities Act (less than 4" off the wall located between 27"-84" from floor)
	recessed depth		luminaire part to be colored (F2)		lamp protected against explosion
	ceiling thickness in mm		luminaire part to be colored (F3)		blown glass using traditional methods by master glass blower
	ceiling thickness selection		luminaire part to be colored (F4)		acoustic material
	dimnable DP (phase), DV (0-10V), DD (dali), DS (step-dim)		luminaire part to be colored (F5)		protection class I, protection insulation
	included or excluded LED driver/transformer/control gear		color of 3-circuit adaptor		protection class II, protection insulation
	separately switchable		indirect diffuser		ETL Certified to UL and CSA Standards
	sensor		direct diffuser		UL Certified to UL and CSA Standards
	remote control		ball-proof (upon request)		CSA Certified to UL and CSA Standards
	available upon request		accessory		Certified for North American Standards

IP RATING

	protected against ingress of solid bodies greater than 12.5mm (finger)
	protected against ingress of solid bodies greater than 2.5mm protected against sprays of water up to 60 degrees from the vertical (rain)
	protected against ingress of solid bodies greater than 1mm (wire) no protection against the ingress of moisture
	protected against ingress of solid bodies greater than 1mm (wire) protected against sprays of water up to 60 degrees from the vertical (rain)
	protected against ingress of solid bodies greater than 1mm (wire) protected against water splashed from all directions
	protected against limited ingress of dust (wet rooms/covered outdoor areas) protected against water splashed from all directions
	protected against ingress of dust protected against jets of water
	protected against ingress of dust protected against powerful jets of water or heavy seas
	protected against ingress of dust protected against immersion of water between 15cm - 1m for 30 minutes
	protected against ingress of dust protected against immersion of water under pressure for long periods

IK RATING

	protected against 0.14 joules impact (equivalent to 0.25kg mass dropped from 56mm above the surface)
	protected against 0.2 joules impact (equivalent to 0.25kg mass dropped from 80mm above the surface)
	protected against 0.35 joules impact (equivalent to 0.25kg mass dropped from 140mm above the surface)
	protected against 0.5 joules impact (equivalent to 0.25kg mass dropped from 200mm above the surface)
	protected against 0.7 joules impact (equivalent to 0.25kg mass dropped from 280mm above the surface)
	protected against 1 joules impact (equivalent to 0.25kg mass dropped from 400mm above the surface)
	protected against 2 joules impact (equivalent to 0.5kg mass dropped from 400mm above the surface)
	protected against 5 joules impact (equivalent to 1.7kg mass dropped from 300mm above the surface)
	protected against 10 joules impact (equivalent to 5.0kg mass dropped from 200mm above the surface)
	protected against 20 joules impact (equivalent to 5.0kg mass dropped from 400mm above the surface)